

PRACTICAS DE CONEXIÓN DE ELEMENTOS DE MANOBRA

1. Monta o circuito e debuxa o cableado:

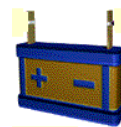
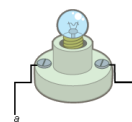
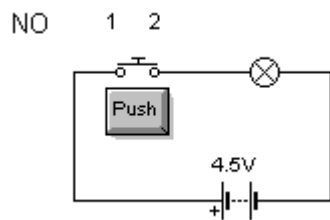

Explica o funcionamento:

2. Monta o circuito e debuxa o cableado:

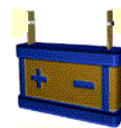
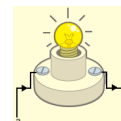
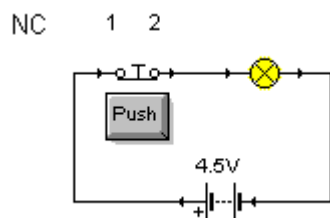

Explica o funcionamento:

3. Monta o circuito e debuxa o cableado:

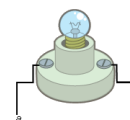
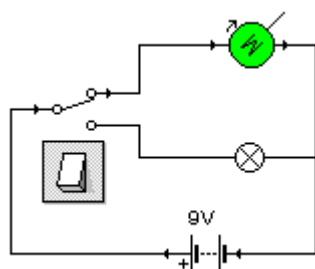

Explica o funcionamento:

4. Monta o circuito e debuxa o cableado:

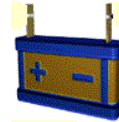
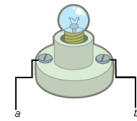
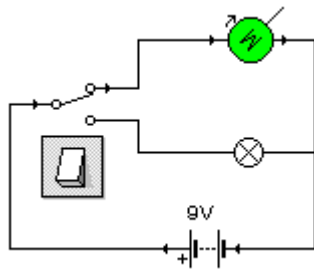

Explica o funcionamento:

5. Monta o circuito e debuxa o cableado:

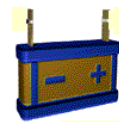
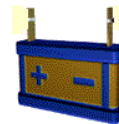
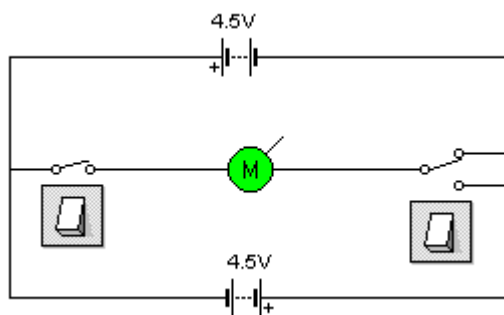

Explica o funcionamento:

6. Monta o circuito e debuxa o cableado:

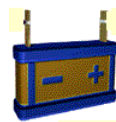
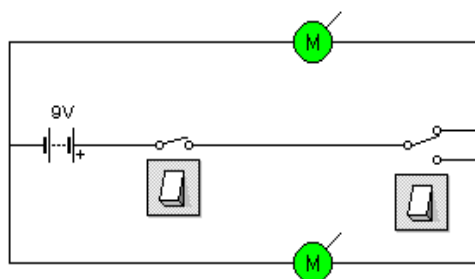

Explica o funcionamento:

7. Monta o circuito e debuxa o cableado:

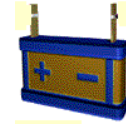
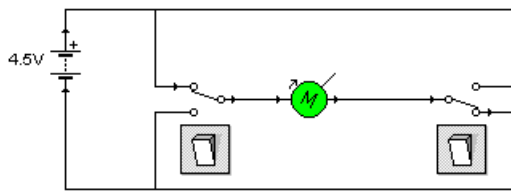

Explica o funcionamento:

8. Monta o circuito e debuxa o cableado:

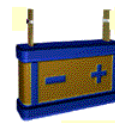
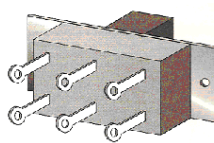
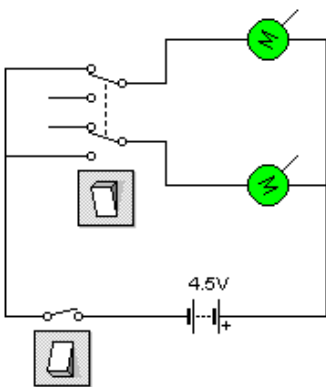

Explica o funcionamento:

9. Monta o circuito e debuxa o cableado:

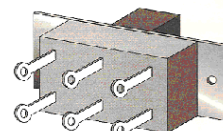
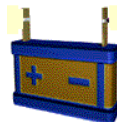
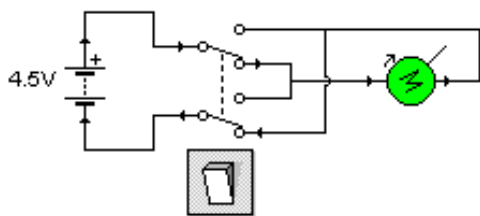

Explica o funcionamento:

10. Debuxa a conexión do robot "pegatortas", e explica o seu funcionamento:

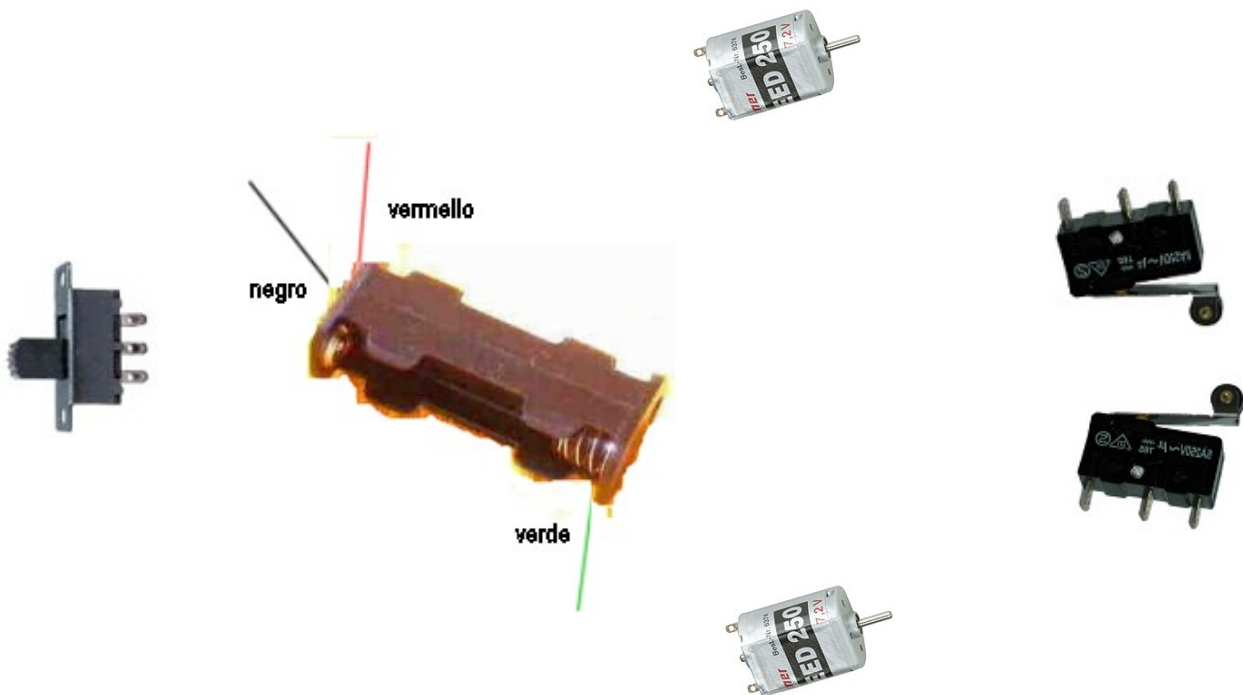
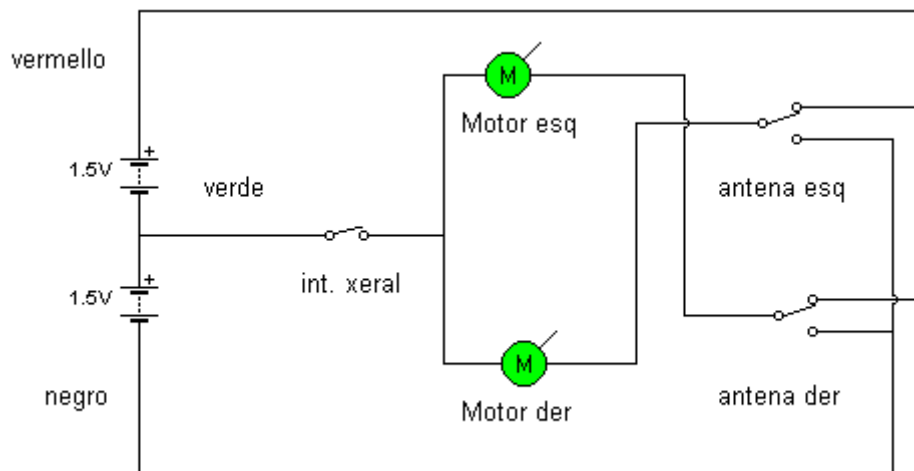

Explica o seu funcionamento: